

Features

- Indoor air quality transmitter/controller
- Internal sensors to measure CO2 & temperature & RH
- 3-color backlight LCD display
- Four function keys to adjust setpoints
- Providing 3x analog outputs
- Linear or PID output selectable for analog
- Modbus RS485 interface to connect to BMS/PLC
- 24VAC/VDC power supply

Specification

Carbon Dioxide	
Detecting gas	Carbon Dioxide (CO2)
Gas sensor	NDIR sensor
Accuracy@25°C	±50ppm + 3% reading or ±75ppm (whichever is greater)
Stability	<2% of FS over lifetime (15 years) of sensor
Calibration	ABC Logic self-calibration
Lifetime of NDIR CO2 sensor	15 years (normal using)
Response time	<2 minutes for 90% step change
Sample time	Every 2 seconds
Warm up time	2 hours (first time or startup after power failure) 2 min (operation)
CO2 measuring range	0~2000ppm (default) 0~5000ppm (selected in Advanced Setup)
CO2 display resolution	1ppm
Temperature & Relative Humidity	
Temperature sensor (selectable)	High precision digital integrated temperature and humidity sensor SHT
Measuring range	0~50°C (default) 0~100%RH
Accuracy	Temp.: <±0.5°C@25°C RH: <±3.0%RH (20%~80%RH)
Electrical Specification and Functions	
Power supply	24VAC/VDC
Power consumption	5.5 W max. ; 2.5 W avg.
LCD screen	3-color backlight LCD screen, with 4 function keys
Output	3× analog outputs Analog: linear (0~10V or 4~20mA) or PID
Communication interface	Modbus RS485
Operation Condition	
Working condition	0~50°C; 0~95%RH, non condensing
Storage condition	-10~60°C, 0~80%RH
Dimension/Weight	150mm(L)×90mm(W)×42mm(H)/280g

Installation method	Wall mount (65mm×65mm or 2"×4" wire box)
Housing and IP class	PC/ABS, IP class: IP30
Certification	EMC approval
Version	V.103

Mounting and installation instruction

- ◆ Notice the power supply of the monitor is 24VAC/VDC. Do not connect higher voltages than marked on the transmitter/controller. Always turn off power before taking following steps.
- ◆ Open the cover: push both clips at the bottom of the unit to remove the front cover from the back cover. Please operate gently to avoid damaging of the clips.
- ◆ Fix back cover: fix the back cover on the wall according to the dimension and position, see Figure 1.
- ◆ Connect wires: connect wires according to Figure 2 and press the wires under the terminals of back cover.
- ◆ Close the cover: align the top clip of the unit firstly, then close the front cover and back cover by pressing the bottom clips, to finish the installation.

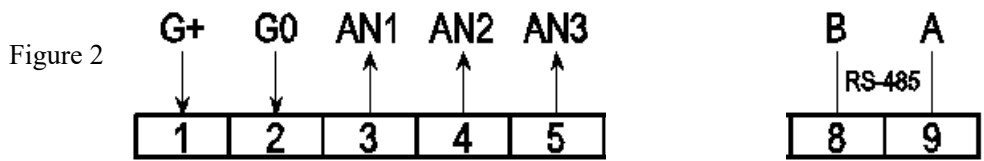
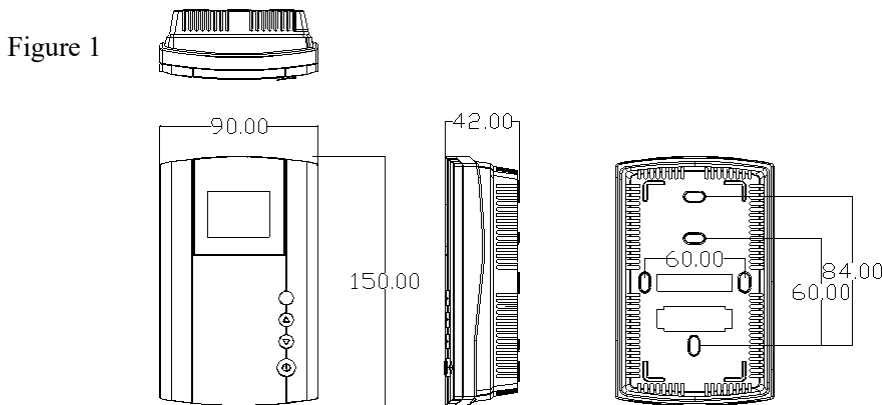

Connection Terminal		Function	Electrical Data
1	G+	Power (+)	24VAC/24VDC +
2	G0	Power ground (-)	24VAC/24VDC
3	AN1 (CO ₂)	Analog output (+)	0~10VDC correspond to CO ₂ range 0~2000ppm
4	AN2 (Temp.)	Analog output (+)	0~10VDC correspond to temp. range 0~50℃
5	AN3 (RH)	Analog output (+)	0~10VDC correspond to RH range 0~100%RH
8	B	RS485 interface	
9	A		

Instruction

1. Please always cut off the power before open or clean the detector.
2. After the monitor is powered on, it can be turned on/off by pressing the power button . The factory setting of the monitor is turning on. Then the detector enter in user interface, see Figure 3.

Figure 3



3. In the user interface, long press the SET key about 6 seconds to enter the parameter setting interface, see Figure 4. Press SET key to switch setting items, and press ▲ or ▼ key to modify the setting parameters. When the number does not flash, new setting value is saved. If it is not operated for 3 seconds, it will exit from the parameter setting interface and return to the user interface. The specific parameters are as follows.

Item	Parameter	Setting range	Default
-1	CO2 setpoint for AN1 PID	0~5000ppm	800
-2	Temp. setpoint for AN2 PID	-20.0~60.0°C	21.0
-3	Humi. setpoint for AN3 PID	0~100.0%RH	50.0
-4	CO2 control mode for the relay	1 ~ 4 (Invalid for this model)	1
-5	Temp. control mode of the relay	1 ~ 4 (Invalid for this model)	1
-6	Humi. control mode of the relay	1 ~ 4 (Invalid for this model)	1

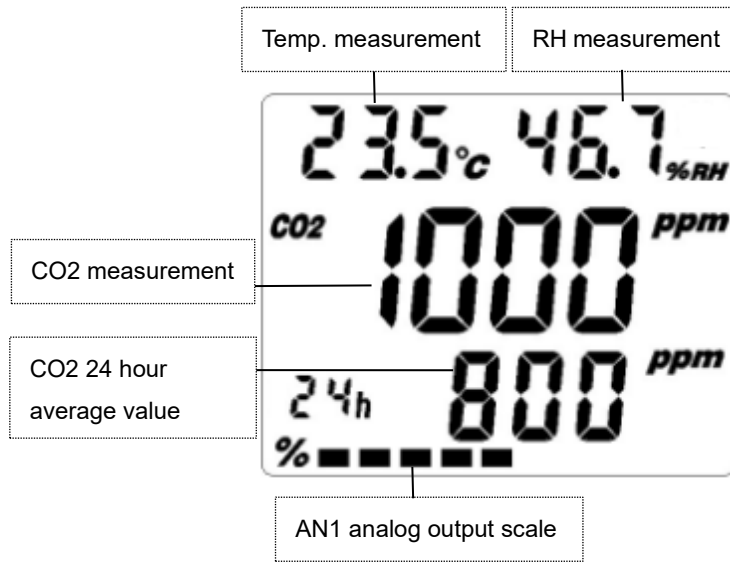
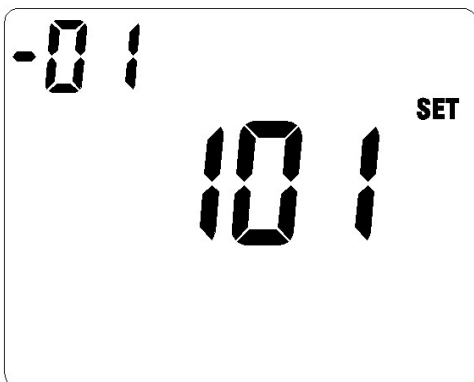

Figure 4

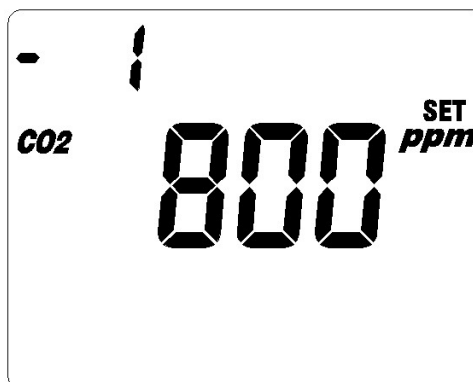

Figure 5

4. In the user interface, long press ▲ and ▼ keys simultaneously about 6 seconds until entering the advanced setup interface, see Figure 5. Press SET key to switch setting items, and press ▲ or ▼ key to modify the setting parameters. When the number does not flash, new setting value is saved. In the advanced setup interface, long press ▲ and ▼ keys simultaneously about 6 seconds, it will return to the user interface. The specific parameters are as follows.

Item	Parameter	Setting range	Default
-01	Firmware version		103
-02	Disable/enable buttons	1-all buttons usable 2-"power" button disable 3-"SET" button disable	1
-03	Temp. unit	0-°C 1-°F	0
-04	RS485 address	1~247	1
-05	RS485 baud rate	1-4800 2-9600 3-14400 4-19200 5-38400 6-56000 7-57600 8-115200	2
-06	RS485 parities and stop bit	1-None 1 Stop Bit; 2-None 2 Stop Bit; 3-Odd 1 Stop Bit; 4-Even 1 Stop Bit	2
-07	CO2 correction value	-300 ~ 300 ppm	0
-08	Temp. correction value	-9.9~9.9°C	-2.0
-09	Humidity correction value	-20.0 ~ 20.0 %RH	3.0
-10	TVOC single target value correction (Invalid for this model)	0.0 ~ 30.0ppm	0.0
-11	CO2 setpoint for Green to Yellow backlight	600 ~ 5000ppm	800
-12	CO2 setpoint for Yellow to Red backlight	800 ~ 5000ppm	1200
-13	TVOC setpoint for Green to Yellow backlight (Invalid for this model)	10.0 ~ 30.0ppm	10.0
-14	TVOC setpoint for Yellow to Red backlight (Invalid for this model)	15.0 ~ 30.0ppm	20.0
-15	Power on again choice	1- turn off 2- turn on after power up again 3- keep the mode before the power failure	3
-16	The relay mode for CO2 (Invalid for this model)	1 ~ 4 1-auto control relay ON1, reduce CO2 2-auto control relay ON1, increase CO2 3-hand control relay ON1, OFF 4-hand control relay ON1, ON	1
-17	The relay mode for Temp. (Invalid for this model)	1 ~ 4 (This model is invalid)	3
-18	The relay mode for Humi (Invalid for this model)	1 ~ 4 (This model is invalid)	3
-19	The relay mode for TVOC (Invalid for this model)	1 ~ 4 (This model is invalid)	3
-20	CO2 control relay offset (Invalid for this model)	10 ~ 5000ppm	10
-21	Temp. control relay offset (Invalid for this model)	1°C ~ 60.0°C	1.0
-22	Humi. control relay offset (Invalid for this model)	0.0 ~ 100.0 %RH	1.0
-23	TVOC control relay offset (Invalid for this model)	0.0 ~ 30.0ppm	1.0

-24	AN1~AN3 PID or Linear output choice	0 ~ 15 (see Table1 Analog output: linear or PID output on page 7)	15
-25	AN1 CO2 linear min measure	0 ~ 1000ppm	0
-26	AN1 CO2 linear max measure	400 ~ 5000ppm	2000
-27	AN1 CO2 linear output	0-0~10V/0~20mA 1-2~10V/4~20mA 2-0~5V	0
-28	AN2 Temp. linear min measure	-20.0 ~ 20.0°C	0.0
-29	AN2 Temp. linear max measure	0 ~ 60.0°C	50.0
-30	AN2 Temp. linear output	0-0~10V/0~20mA 1-2~10V/4~20mA 2-0~5V	0
-31	AN3 Humi. linear min measure	0.0 ~ 80.0%RH	0.1
-32	AN3 Humi. linear max measure	10 ~ 100.0%RH	100.0
-33	AN3 Humi. linear output	0-0~10V/0~20mA 1-2~10V/4~20mA 2-0~5V	0
-34	TVOC linear output (Invalid for this model)	0-0~10V/0~20mA 1-2~10V/4~20mA 2-0~5V	0
-35	AN2 output choice	0- output for temp. 1- the bigger value whatever CO2 or temp. PID output	0
-36	AN3 output choice (Invalid for this model)	0-AN3 output for humidity 1-AN3 output for TVOC	0
-37	CO2 PID control mode	0-PID output is zero 1-PID output to decrease CO2 2-PID output to increase CO2	1
-38	Temp. PID control mode	0-PID output is zero 1-PID output is for cooling 2-PID output is for heating	1
-39	Humi. PID control mode	0-PID output is zero 1-PID output to dehumidify 2-PID output to humidify	1
-40	TVOC PID control mode (Invalid for this model)	0- PID output is zero 1- PID output to ventilate	1
-41	CO2 PID period setpoint	1 ~ 9999	10
-42	CO2 PID-P setpoint	0 ~ 100	20
-43	CO2 PID-I setpoint	0~ 120	10
-44	CO2 PID-D setpoint	0 ~ 120	2
-45	Temp. PID period setpoint	1 ~ 9999	10
-46	Temp. PID-P setpoint	0 ~ 100	20
-47	Temp. PID-I setpoint	0~ 120	10

-48	Temp. PID-D setpoint	0 ~ 120	2
-49	Humi. PID period setpoint	1 ~ 9999	10
-50	Humi. PID-P setpoint	0 ~ 100	20
-51	Humi. PID-I setpoint	0~ 120	10
-52	Humi. PID-D setpoint	0 ~ 120	2
-53	TVOC PID period setpoint (Invalid for this model)	1 ~ 9999	10
-54	TVOC PID-P setpoint (Invalid for this model)	0 ~ 100	20
-55	TVOC PID-I setpoint (Invalid for this model)	0~ 120	10
-56	TVOC PID-D setpoint (Invalid for this model)	0 ~ 120	2
-57	Force AN1 output to 10V for night ventilation in summer choice	0: AN1 normal output; 1~100: force AN1 output 1~100% of 10V	0
-58	CO2 max measurement value	0 ~ 5000ppm	2000
-59	CO2 elevation setpoint	0 ~ 5000 feet	0
-60	CO2 ABC Logic (Not recommended, and only available for T67X3)	1-ABC Logic ON 2-ABC Logic OFF	1
-61	CO2 single-point calibration target value (Not recommended, and only available for T67X3)	350 ~ 5000ppm	400
-62	CO2 single-point calibration on/off (Not recommended, and only available for T67X3)	0-Do not perform single-point calibration; 1-Start single-point calibration of CO2 module (It takes about 10 minutes, wait until this value is changed from 1 to 0 to complete the calibration.)	0
-63	TVOC AD adjust setpoint (Invalid for this model)	-500 ~ 500 (TVOC AD calibration value)	0
-64	Relay and analog output test	0-AN1 AN2 AN3 ON1 run normally 1-AN1=AN2=AN3=0V/0mA and ON1=OFF 2-AN1=AN2=AN3=2V/4mA and ON1=OFF 3-AN1=AN2=AN3=10V/20mA and ON1=ON	0
-65	Which parameter controls ON1	0~3 0-CO2 1-Temp. 2-Humi. 3-TVOC	0

Analog Output Setting

1. Hardware output and settings: As shown in Figure 1, it provides 3 analog outputs, and the negative electrode of the analogs shares the G0 position. The factory default setting AN1 corresponds to CO2, AN2 corresponds to temperature, and AN3 corresponds to humidity. Figure 6 shows the internal hardware settings of the monitor, switches through the short-circuit block on the pins to switch the voltage or current output.

Figure 6

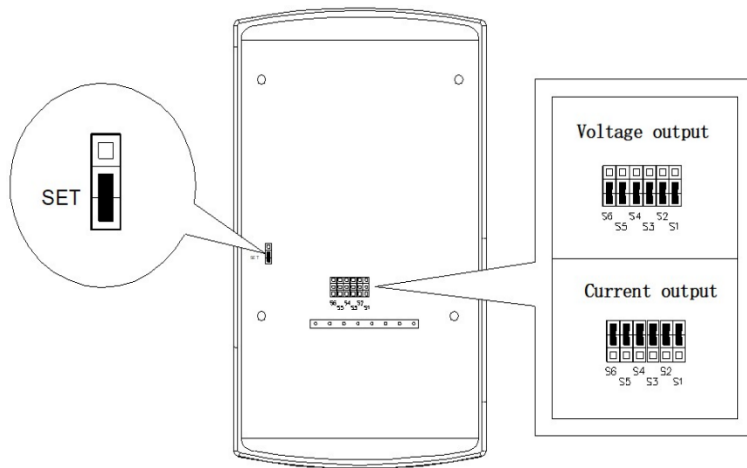

2. Function setting: As shown in advanced setting, 0~10V/0~20mA or 2~10V/4~20mA or 0~5V output for CO2, temp. & RH can be selected on items -27, -30, and -33. The analog output is linear or PID selection, which needs to be set through the items -24 in advanced settings. The -24 item setting is shown in the below table.

Advanced parameter setting	CO2 (AN1)	Temperature (AN2)	RH (AN3)
0	Linear	Linear	Linear
1	PID	Linear	Linear
2	Linear	PID	Linear
3	PID	PID	Linear
4	Linear	Linear	PID
5	PID	Linear	PID
6	Linear	PID	PID
7	PID	PID	PID
8	Linear	Linear	Linear
9	PID	Linear	Linear
10	Linear	PID	Linear
11	PID	PID	Linear
12	Linear	Linear	PID
13	PID	Linear	PID
14	Linear	PID	PID
15	PID	PID	PID

Table 1 Analog output: linear or PID output

Restore factory settings (NOT RECOMMENDED)

As shown in Figure 6, the SET position of the internal PCB board of the monitor, the factory default is to connect the two pins below. When the user needs to restore the factory settings, connect the two pins above. At this time, 8888 flashes in the middle of the screen, see Figure 7, and 8888 stops flashing after the reset is completed. Then the monitor goes to booting interface, press power button to go to user interface.

Figure 7



Modbus Parameters V4.0

Mode: RTU (MSB First)

Baud Rate: 9600,14400,19200,38400,56000,57600,115200bps

default: 2-9600

Start Bits: 1

Data Bits: 8

Stop Bits: 1 / 2

default : 1

Parity: None / Odd / Even

default: None

Register Map Support Function: 3 4 6 16

Starting Register Decimal Address (Base 0)	Data Description	Function	Read/Write	Length	Format	Valid Response	Default	Correspond Advanced Setting
Function 4: Read Input Registers								
0	Co2 Measurement	4	R	2	Float Big-endian	0~5000 ppm		
2	Temp. Measurement	4	R	2	Float Big-endian	-20.0~60.0°C/-40.0~140.0°F		
4	Humi. Measurement	4	R	2	Float Big-endian	0.1~100.0 RH%		
10	Co2 Measurement	4	R	1	UINT16	0~5000 ≥0~5000 ppm		
11	Temp. Measurement x 1	4	R	1	INT16	-20~60 ≥-20~60°C -40~140≥-40~140°F		
12	Humi. Measurement x 1	4	R	1	UINT16	1~100 ≥1~100 RH%		
20	Co2 Measurement	4	R	1	UINT16	0~5000 ≥0~5000 ppm		
21	Temp. Measurement x 10	4	R	1	INT16	-200~600 ≥-20.0~60.0°C/ -400~1400≥-40.0~140.0°F		
22	Humi. Measurement x 10	4	R	1	UINT16	1~1000 ≥0.1~100.0 RH%		
Function 3: Read Holding Registers; Functions 6: Write Single Register; Function 16: Write Multiple Registers								
0	RS485 address	3/6	R/W	1	UINT16	1~247	1	-04
1	RS485 baud rate	3/6	R/W	1	UINT16	2-9600bps 3-14400bps 4-19200bps 5-38400bps 6-56000bps 7-57600bps 8-115200bps	2	-05

2	RS485 paritsy and stops bit	3/6	R/W	1	UINT16	1-None 1 Stop Bit; 2-None 2 Stop Bit; 3-Odd 1 Stop Bit; 4-Even 1 Stop Bit	2	-06
3	Force AN1 output to 10V for night ventilation in summer	3/6	R/W	1	UINT16	0: AN1 normal output; 1~100: force AN1 output 1~100% of 10V	0	-57
4	Disable/enable buttons	3/6	R/W	1	UINT16	1-all buttons usable 2-"power" button disable 3-"SET" button disable	1	-02
5	LCD contrast control	3/6	R/W	1	UINT16	2-5	2	
6	Monitor Turn On/Off after power on	3/6	R/W	1	UINT16	0-Turn On; 1-Turn Off	0	
7	Power on again choice	3/6	R/W	1	UINT16	1-Off; 2-On; 3-Keep	3	-15
8	Temp. unit	3/6	R/W	1	UINT16	1-Degree celsius; 2-Fahrenheit	1	-03
9	AN1~AN3 PID or Linear output choice	3/6	R/W	1	UINT16	0~15 (see Table 1)	15	-24
10	Co2 setpoint for relay1 and AN1 PID	3/16	R/W	2	Float Big-endian	0~5000ppm	800	
12	Temp. setpoint for relay2 and AN2 PID	3/16	R/W	2	Float Big-endian	-20.0~60.0°C	21.0	
14	Humi. setpoint for relay3 and AN3 PID	3/16	R/W	2	Float Big-endian	0~100.0%RH	50.0	
350	Co2 setpoint for relay1 and AN1 PID	3/6	R/W	1	UINT16	0~5000 ≥0~5000ppm	800	
351	Temp. setpoint for relay2 and AN2 PID x 1	3/6	R/W	1	INT16	-20~60 ≥-20~60°C	21	
352	Humi. setpoint for relay3 and AN3 PID x 1	3/6	R/W	1	UINT16	0~100 ≥0~100%RH	50	
360	Co2 setpoint for relay1 and AN1 PID	3/6	R/W	1	UINT16	0~5000 ≥0~5000ppm	800	
361	Temp. setpoint for relay2 and AN2 PID x 10	3/6	R/W	1	INT16	-200~600 ≥-20.0~60.0°C	210	
362	Humi. setpoint for relay3 and AN3 PID x 10	3/6	R/W	1	UINT16	0~1000 ≥0.0~100.0%RH	500	

18	CO2 setpoint for Green to Yellow backlight	3/16	R/W	2	Float Big-endian	1~5000ppm	800	-11
20	CO2 setpoint for Yellow to Red backlight	3/16	R/W	2	Float Big-endian	1~5000ppm	1200	-12
26	CO2 correction value	3/16	R/W	2	Float Big-endian	-300~300.0ppm	0ppm	-07
28	Temp. correction value	3/16	R/W	2	Float Big-endian	-3.0~3.0°C	0.0°C	-08
30	Humidity correction value	3/16	R/W	2	Float Big-endian	-5.0~5.0%RH	0.0 %RH	-09
38	AN3 output choice	3/6	R/W	1	UINT16	0-AN3 output for humidity 1-AN3 output for TVOC	0	-36
39	AN2 output choice	3/6	R/W	1	UINT16	0- output for temp. 1- the bigger value whatever CO2 or temp. PID output	0	-35
40	AN1 CO2 linear min measure	3/16	R/W	2	Float Big-endian	0~5000ppm	0	-25
42	AN1 CO2 linear min volt	3/16	R/W	2	Float Big-endian	0~10.000v	0.000	
44	AN1 CO2 linear max measure	3/16	R/W	2	Float Big-endian	0~5000ppm	2000	-26
46	AN1 CO2 linear max volt	3/16	R/W	2	Float Big-endian	0~10.000v	10.000	
48	AN2 Temp. linear min measure	3/16	R/W	2	Float Big-endian	-20.0~60.0°C	0.0	-28
50	AN2 Temp. linear min volt	3/16	R/W	2	Float Big-endian	0~10.000v	0.000	
52	AN2 Temp. linear max measure	3/16	R/W	2	Float Big-endian	-20.0~60.0°C	50.0	-29
54	AN2 Temp. linear max volt	3/16	R/W	2	Float Big-endian	0~10.000v	10.000	
56	AN3 Humi. linear min measure	3/16	R/W	2	Float Big-endian	0~100.0%RH	0	-31
58	AN3 Humi. linear min volt	3/16	R/W	2	Float Big-endian	0~10.000v	0.000	
60	AN3 Humi. linear max measure	3/16	R/W	2	Float Big-endian	0~100.0%RH	100.0	-32

62	AN3 Humi. linear max volt	3/16	R/W	2	Float Big-endian	0~10.000v	10.000	
84	AN1 CO2 linear output	3/6	R/W	1	UINT16	0-0~10V/0~20mA 1-2~10V/4~20mA 2-0~5V	0	-27
85	AN2 Temp. linear output	3/6	R/W	1	UINT16	0-0~10V/0~20mA 1-2~10V/4~20mA 2-0~5V	0	-30
86	AN3 Humi. linear output	3/6	R/W	1	UINT16	0-0~10V/0~20mA 1-2~10V/4~20mA 2-0~5V	0	-33
88	Which parameter controls ON1	3/6	R/W	1	UINT16	0:co2 1:Temp. 2:Humi. 3:tvoc	0	-65
94	AN1 current analog output	3	R	2	Float Big-endian	0.000~10.000V/4.000~20.000mA		
96	AN2 current analog output	3	R	2	Float Big-endian	0.000~10.000V/4.000~20.000mA		
98	AN3 current analog output	3	R	2	Float Big-endian	0.000~10.000V/4.000~20.000mA		
100	CO2 PID period setpoint	3/16	R/W	2	Float Big-endian	1~9999	10	-41
102	CO2 PID-P setpoint	3/16	R/W	2	Float Big-endian	0~100	20	-42
104	CO2 PID-I setpoint	3/16	R/W	2	Float Big-endian	0~120	10	-43
106	CO2 PID-D setpoint	3/16	R/W	2	Float Big-endian	0~120	2	-44
108	Temp. PID period setpoint	3/16	R/W	2	Float Big-endian	1~9999	10	-45
110	Temp. PID-P setpoint	3/16	R/W	2	Float Big-endian	0~100	20	-46
112	Temp. PID-I setpoint	3/16	R/W	2	Float Big-endian	0~120	10	-47
114	Temp. PID-D setpoint	3/16	R/W	2	Float Big-endian	0~120	2	-48
116	Humi. PID period setpoint	3/16	R/W	2	Float Big-endian	1~9999	10	-49
118	Humi. PID-P setpoint	3/16	R/W	2	Float Big-endian	0~100	20	-50
120	Humi. PID-I setpoint	3/16	R/W	2	Float Big-endian	0~120	10	-51

122	Humi. PID-D setpoint	3/16	R/W	2	Float Big-endian	0~120	2	-52
132	CO2 PID control mode	3/6	R/W	1	UINT16	0-PID output is zero 1-PID output to decrease CO2 2-PID output to increase CO2	1	-37
133	Temp. PID control mode	3/6	R/W	1	UINT16	0-PID output is zero 1-PID output is for cooling 2-PID output is for heating	1	-38
134	Humi. PID control mode	3/6	R/W	1	UINT16	0-PID output is zero 1-PID output to dehumidify 2-PID output to humidify	1	-39
294	CO2 max measurement value	3	R/W	1	INT16	0-5000	2000	-58
295	Co2 ABC Logic now status	3	R	1	UINT16	0-Reading; 1-ABC ON; 2-ABC OFF		
296	Co2 ABC Logic	3/6	R/W	1	UINT16	1-ABC ON; 2-ABC OFF	1	-60
297	Co2 elevation setpoint	3/6	R/W	1	UINT16	0~5000 inch	0	-59
298	CO2 single-point calibration target value	3/6	R/W	1	UINT16	400~5000 ppm	400	-61
299	CO2 single-point calibration on/off	3/6	R/W	1	UINT16	0-stop/finish; 1-start	0	-62
399	Set hardware test	3/6	R/W	1	UINT16	0-AN1 AN2 AN3 ON1 run normally 1-AN1=AN2=AN3=0V/0 mA and ON1=OFF 2-AN1=AN2=AN3=2V/4 mA and ON1=OFF 3-AN1=AN2=AN3=10V/20mA and ON1=ON	0	-64

Note: Scan Rate>=4000ms